

ELECTRIC FENCING

INSULATORS FENCE TOOLS ACCESSORIES

FENCE TESTERS FENCE ENERGIZERS

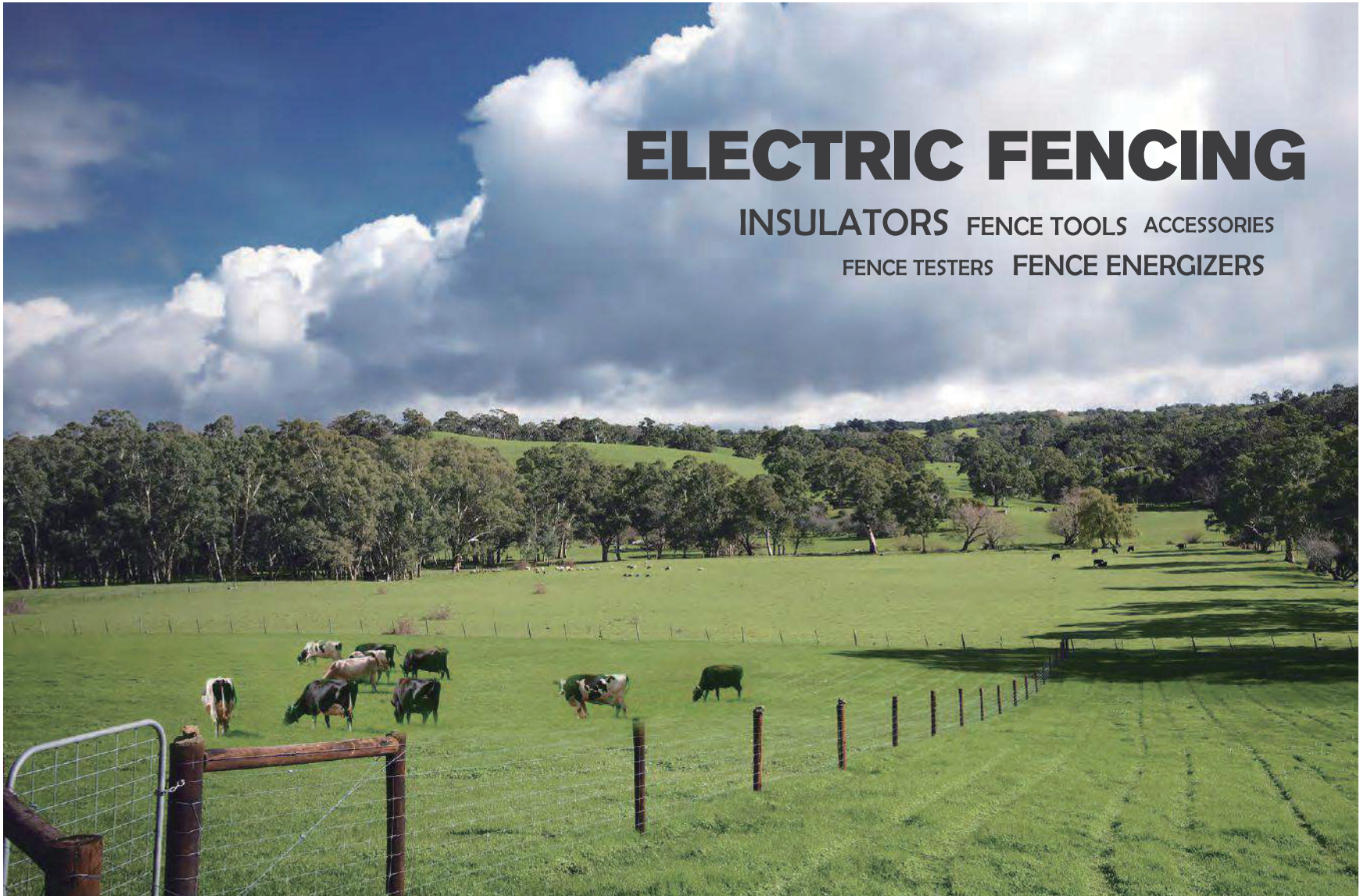

As a leading Chinese manufacturer of electric fences, H.P.S. Exports its products around the world.
Our goal is to achieve a “one-stop” service for farmers.



COMPANY PROFILE

WELCOME TO HANGZHOU OPUS FENCE SUPPLIES CO.,LTD

H.P.S. was created in 2013 with the aim of our main products being farm tools. Since then we have gradually moved into the plastics and electronics industries by constantly developing electric fencing products. As a leading Chinese manufacturer of electric fences, H.P.S. Exports its products around the world.

Through technological innovation and product optimization, we continue to improve our products. We offer a wide range which include insulators, fence tools, fence testers, fence energizers, and accessories. We export our technology worldwide.

We are not only sales exporters, but are the manufacturer of the majority products we sell. We have our own factory set up with the purpose manufacturer only for H.P.S.. We have worked in cooperation with our customers to meet their needs which have also witnessed our growth. We treat every customer's enquiry with honesty and integrity to allow us to answer each customer's question with the best solution at the most competitive and reliable price, and to the most attentive service to meet customers' requirements. Our goal is to achieve a "one-stop" service for farmers.

TAPE CONNECTOR

TPR001

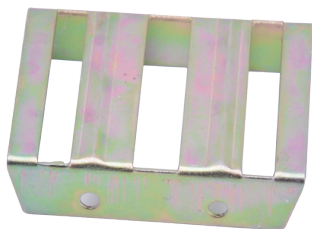

Product Parameter

Item Name	Tape connector
Item No	TPR001
Type	Fencing,trellis&Gates
Material	Steel
Unit Weight	11.2g
Product Size	22.5mm*47mm
Color	Color Galvanized
Packing Size	38.5*27.5*27.5cm
MOQ	1600pcs

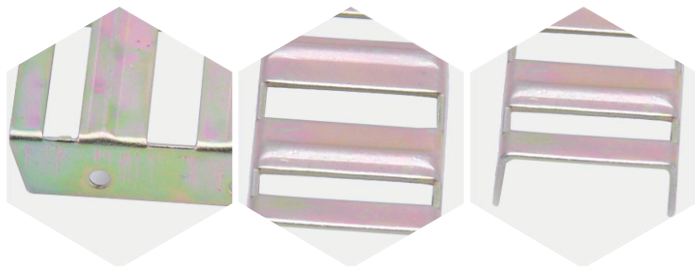

Use Flow

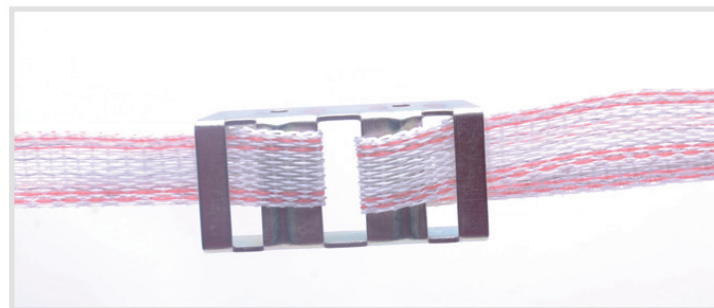

Features

- ✓ Get both ends of the tape and insert through one of the ends slots of the 20 mm tape connector
- ✓ Loop at the two ends of tape over and insert through the middle slot.
- ✓ The two ends of tape then come back from the underside of the connector and go up through the end slot.To create and S shape.
- ✓ Taking the two ends of tape and take them back down through the first slot.This is the first slot that was used in the top image.
- ✓ If required gently adjust the length of tape to suit.
- ✓ Pull the tape tight and the connector is finished. We find this 40 mm electric fencing tape connector to be both exceptionally strong and very conductive.

TAPE CONNECTOR

TPR002

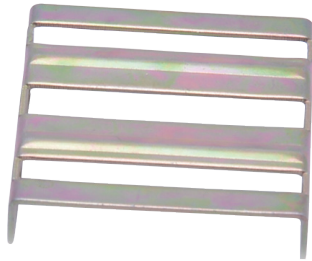

Product Parameter

Item Name	Tape connector
Item No	TPR002
Type	Fencing,trellis&Gates
Material	Steel
Unit Weight	15.5g
Product Size	42.5mm*42.5mm
Color	Color Galvanized
Packing Size	38.5*27.5*27.5cm
MOQ	1000pcs

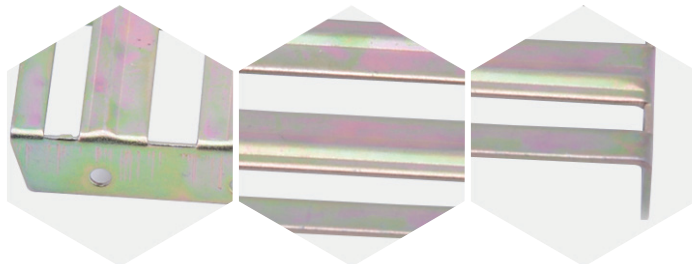

Use Flow

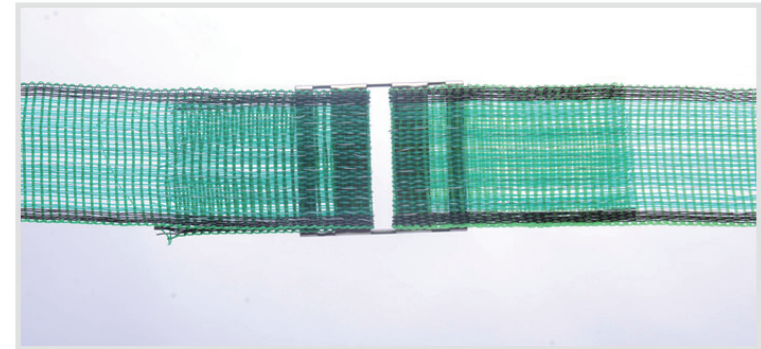

Features

- ✓ Get both ends of the tape and insert through one of the ends slots of the 20 mm tape connector
- ✓ Loop at the two ends of tape over and insert through the middle slot.
- ✓ The two ends of tape then come back from the underside of the connector and go up through the end slot.To create and S shape.
- ✓ Taking the two ends of tape and take them back down through the first slot.This is the first slot that was used in the top image.
- ✓ If required gently adjust the length of tape to suit.
- ✓ Pull the tape tight and the connector is finished. We find this 40 mm electric fencing tape connector to be both exceptionally strong and very conductive.

TAPE CONNECTOR

TPR003

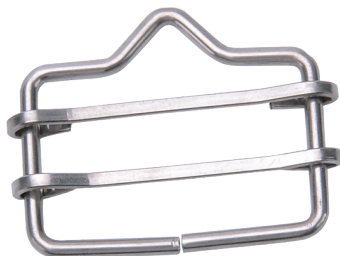

Product Parameter

Item Name	Tape connector
Item No	TPR003
Type	Fencing,Trellis&Gates
Material	Stainless Steel
Unit Weight	11.3g
Fit for	Up to 20mm, 40mm tape
Packing Size	36*36*13cm
Color	Sliver
MOQ	1000pcs

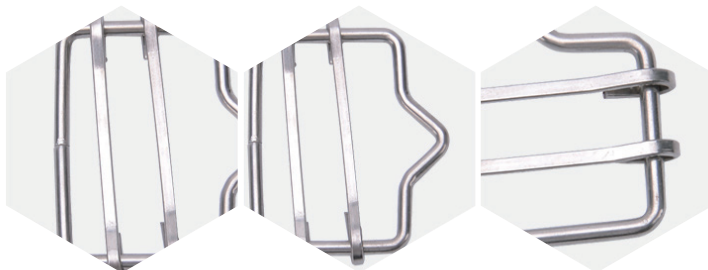

Use Flow

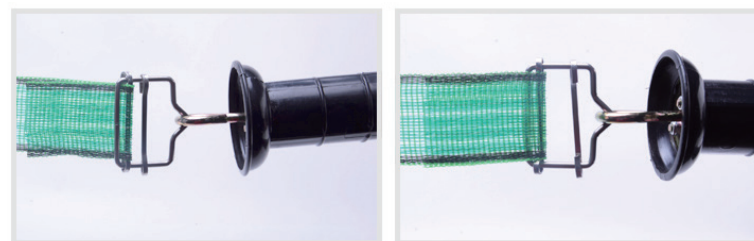

Features

- ✓ Easily connects one strand of polytape to another
- ✓ You can use this to hook a gate handle if you want to make your own gates.
- ✓ These tape ends are a must if you are using 1" polytape
- ✓ Connects one polytape to another without losing juice
- ✓ These ensure a good continuity of current between tapes - essential for an effective electric fence. If a fence made from electric tape is tied together then it is inevitable that many conductors will not touch each other and the fence loses effectiveness as it extends away from the energiser. These buckle type connectors allow one tape to join to another without any loss in conductivity as the connector becomes "live" and all the conductors in each tape become electrified.

TAPE CONNECTOR

TPR004



Product Parameter

Item Name	Tape connector
Item No	TPR004
Type	Fencing,Trellis&Gates
Material	Stainless steel
Unit Weight	8.5g
Fit for	20mm/40mm tape
Paking Size	1000pcs/ctn
Color	36*36*13cm
MOQ	1500pcs

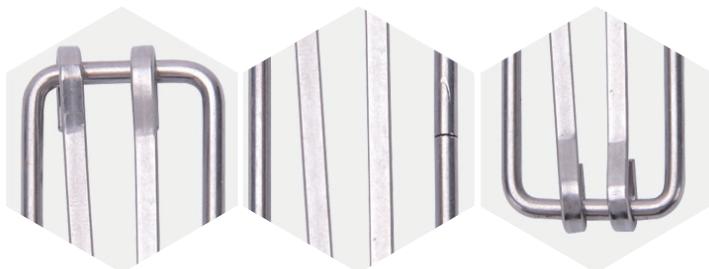

Use Flow

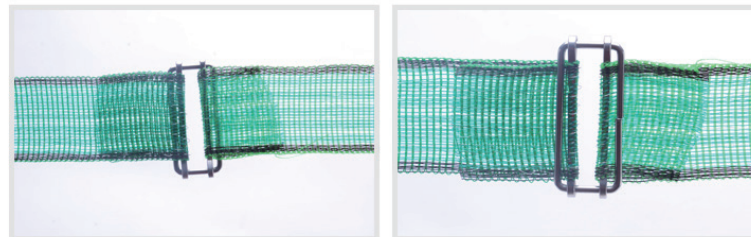

Features

- ✓ Two lines of metal to hold tape
- ✓ Thread two lines of tape into connector and tighten and it will join the tape and pass the current through the connector.
- ✓ Will make the fence look neat by not twisting the tape.
- ✓ Electric connection much better than just tying the tape together.
- ✓ Tape will occasionally break, or be cut. Similarly a gate is essential. With this in mind, HPS has developed purpose designed gates and joining buckles plus other spare parts to keep the system in trim and looking neat and tidy.

TAPE CONNECTOR

WNR001



Product Parameter

Item Name	Polywire joiner
Item No	WNR001
Material	Aluminum
Treatment	Galvanized
Size	2mm,3mm,4mm,5mm,6mm,8mm
Packing	2000pcs/ctn

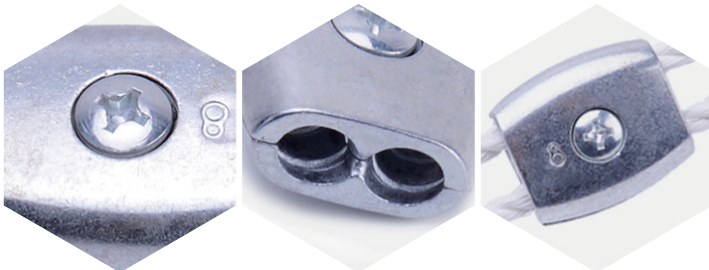

Use Flow



Features

- ✓ Easy to install and remove
- ✓ Low cost but high efficiency
- ✓ Aluminium splice buckle for splicing rolls of Hot Rope or terminating an end of a run.
- ✓ Provides a strong connection with maximum conductivity.
- ✓ 6 Sizes:2mm,3mm,4mm,5mm,6mm,8mm

TAPE CONNECTOR

WNR002



Use Flow

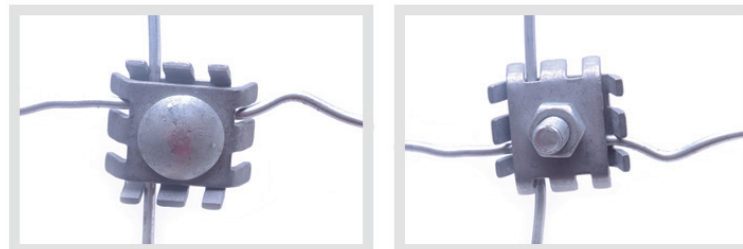

Product Parameter

Item Name	Claw joint clamp
Item No	WNR002
Material	Steel
Treatment	Hot galvanized
Unit Weight	50g
Fit for	Up to 4mm wires
Packing	500pcs/ctn
Packing Size	30x26x20cm
MOQ	1000pcs

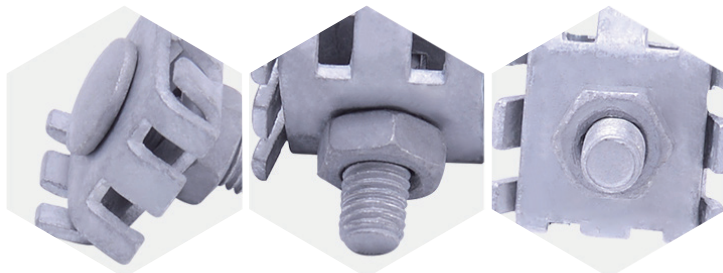
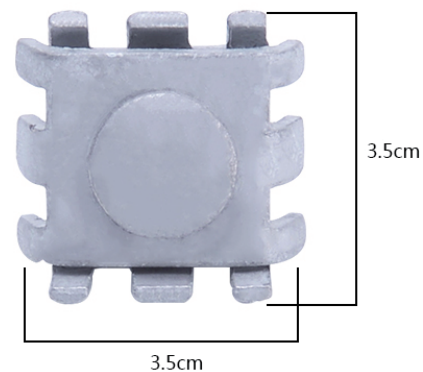

Features

- ✓ Heavy duty construction
- ✓ Heavily galvanized for durability and long life
- ✓ Suitable for all wire sizes up to 2.5mm
- ✓ Great for secure electrical connection , ensures effective electrical joints in the system

TAPE CONNECTOR

WNR004



Use Flow



Product Parameter

Item Name	Joint clamps
Item No	WNR004
Material	Aluminum
Unit Weight	40g
Fit for	Up to 2.5mm wires
Packing	2000pcs/ctn

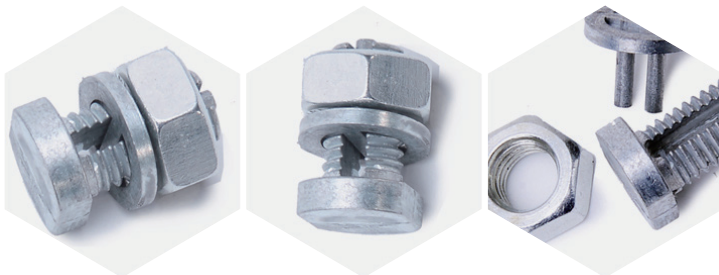
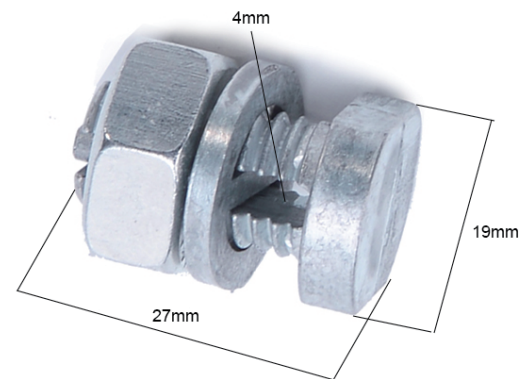

Features

- ✓ Heavy duty construction
- ✓ Heavily galvanized for durability and long life
- ✓ Suitable for all wire sizes up to 2.5mm
- ✓ Great for secure electrical connection , ensures effective electrical joints in the system

TAPE CONNECTOR

WNR005



Use Flow



Product Parameter

Item Name	Crimp sleeve
Item No	WNR005
Material	Aluminum
Treatment	Galvanized
Fit For	Up to 2.5mm wires
Packing	2000pcs/ctn
Packinf Size	34.5x25.5x13.5cm
MOQ	2000pcs

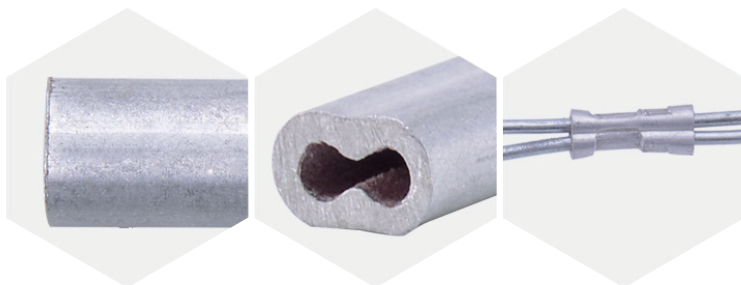
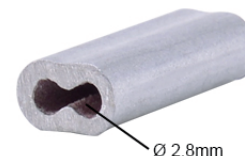
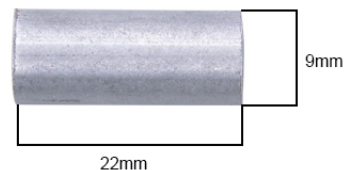

Features

This electric fence gritted crimping sleeve can Quickly splicing wire, in-line strainers or loops at end posts of high tensile or other fence systems. These have superior wire-gripping for strong splices. Use with 12-1/2 gauge wire.

- ✓ Aluminum casted
- ✓ High quality
- ✓ The electric fence gritted crimping sleeve is the perfect way to get a proper connection for your joins so you don't lose your voltage on the fence and also the most secure way of making joins.

TAPE CONNECTOR

WNR006



Product Parameter

Item Name	Crimp sleeve
Item No	WNR006
Material	Aluminum
Treatment	Galvanized
Feature	Single hole
Fit For	Up to 2.5mm wires
Packing	2000pcs/ctn
Packinf Size	34.5x25.5x13.5cm
MOQ	5000pcs

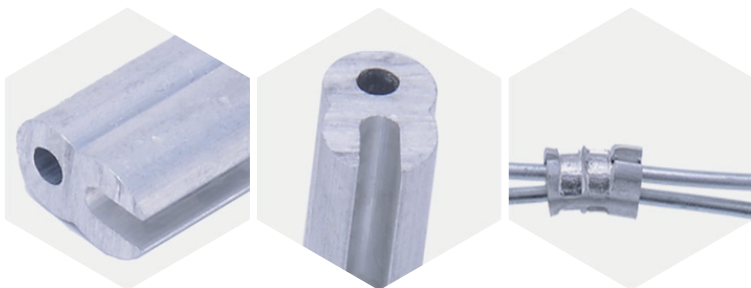

Use Flow

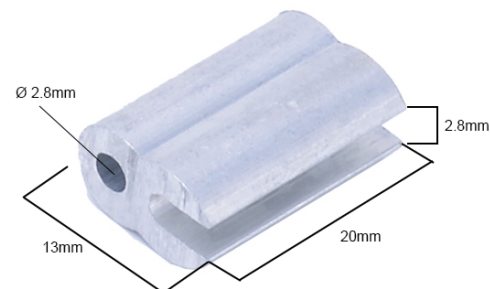

Features

This electric fence gritted crimping sleeve can Quickly splicing wire, in-line strainers or loops at end posts of high tensile or other fence systems. These have superior wire-gripping for strong splices. Use with 12-1/2 gauge wire.

- ✓ Aluminum casted
- ✓ High quality
- ✓ The electric fence gritted crimping sleeve is the perfect way to get a proper connection for your joins so you don't lose your voltage on the fence and also the most secure way of making joins.

TAPE CONNECTOR

WNR007



Use Flow

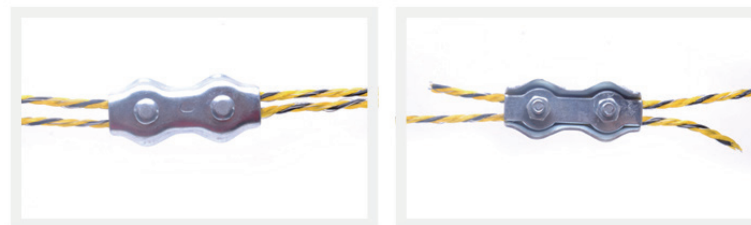

Product Parameter

Item Name	Rope connector
Item No	WNR007
Type	Fencing, Trellis & Gates
Material	Galvanised
Unit Weight	25g
Usage	4mm
Packing Size	38.5*27.5*27.5cm
Usage	Connection of polywire and electrified rope
MOQ	100pcs

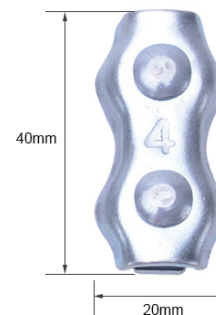

Features

- ✓ Two lines of metal to hold tape
- ✓ Thread two lines of tape into connector and tighten and it will join the tape and pass the current through the connector.
- ✓ Will make the fence look neat by not twisting the tape.
- ✓ Electric connection much better than just tying the tape together.
- ✓ Tape will occasionally break, or be cut. Similarly a gate is essential. With this in mind, HPS has developed purpose designed gates and joining buckles plus other spare parts to keep the system in trim and looking neat and tidy.

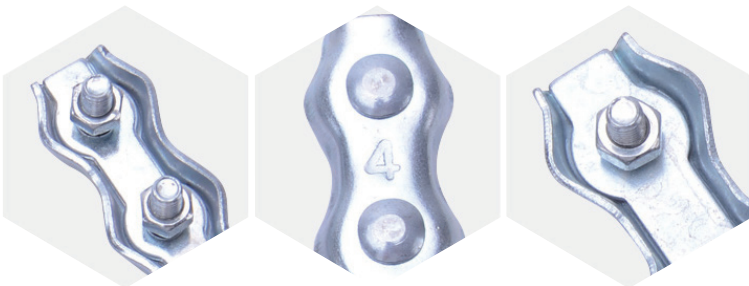

TAPE CONNECTOR

WNR008

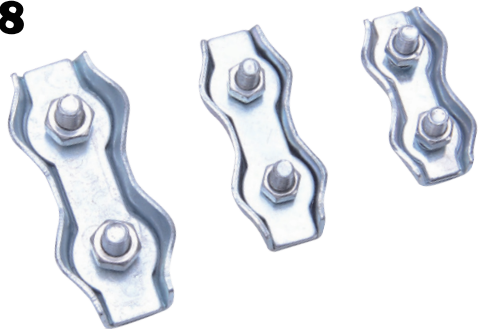

Product Parameter

Item Name	Rope connector
Item No	WNR008
Type	Fencing, Trellis & Gates
Material	Galvanised
Unit Weight	27.5g
Usage	5mm
Paking Size	38.5*27.5*27.5cm
Usage	Connection of polywire and electrified rope
MOQ	1000pcs



Use Flow

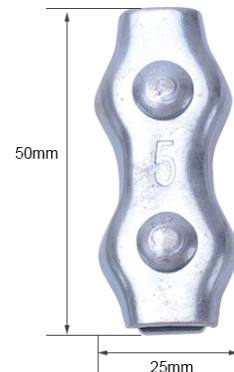
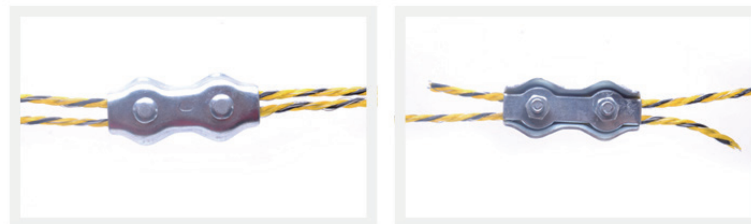

Features

- ✓ Two lines of metal to hold tape
- ✓ Thread two lines of tape into connector and tighten and it will join the tape and pass the current through the connector.
- ✓ Will make the fence look neat by not twisting the tape.
- ✓ Electric connection much better than just tying the tape together.
- ✓ Tape will occasionally break, or be cut. Similarly a gate is essential. With this in mind, HPS has developed purpose designed gates and joining buckles plus other spare parts to keep the system in trim and looking neat and tidy.

TAPE CONNECTOR

WNR009

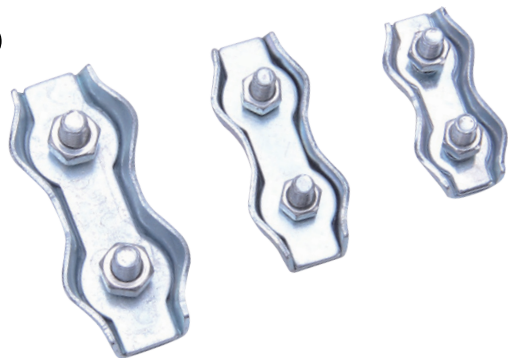

Product Parameter

Item Name	Rope connector
Item No	WNR009
Type	Fencing, Trellis & Gates
Material	Galvanised
Unit Weight	42.5g
Usage	6mm
Paking Size	38.5*27.5*27.5cm
Usage	Connection of polywire and electrified rope
MOQ	1000pcs



Use Flow

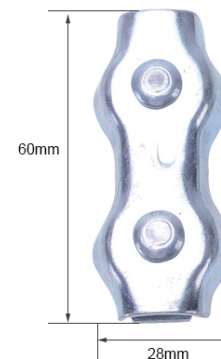

Features

- ✓ Two lines of metal to hold tape
- ✓ Thread two lines of tape into connector and tighten and it will join the tape and pass the current through the connector.
- ✓ Will make the fence look neat by not twisting the tape.
- ✓ Electric connection much better than just tying the tape together.
- ✓ Tape will occasionally break, or be cut. Similarly a gate is essential. With this in mind, HPS has developed purpose designed gates and joining buckles plus other spare parts to keep the system in trim and looking neat and tidy.



HANGZHOU OPUS FENCE SUPPLIES CO.,LTD

Tel: 86-571-89774060

Fax: 86-571-89774057

Email: hps01@hpsunionpower.com

Add: D406, No.11, Xiyuan 8th Road, West Lake Science&
Technology Park Hangzhou, China, 310030

www.hpsfence.com

<http://hpsfence.en.alibaba.com>