

ELECTRIC FENCING

INSULATORS FENCE TOOLS ACCESSORIES

FENCE TESTERS FENCE ENERGIZERS

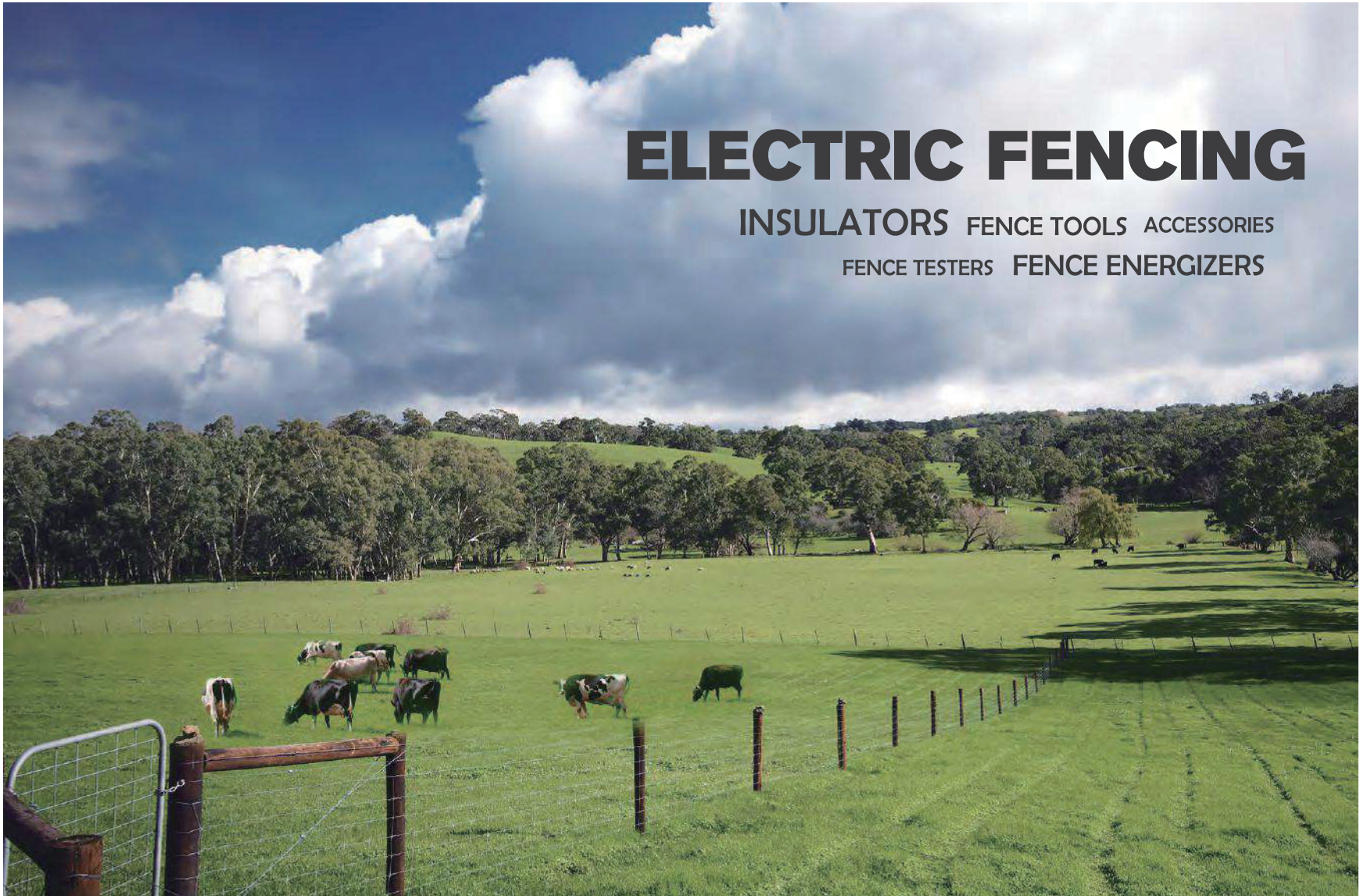

As a leading Chinese manufacturer of electric fences, H.P.S. Exports its products around the world.
Our goal is to achieve a “one-stop” service for farmers.



COMPANY PROFILE

WELCOME TO HANGZHOU OPUS FENCE SUPPLIES CO.,LTD

H.P.S. was created in 2013 with the aim of our main products being farm tools. Since then we have gradually moved into the plastics and electronics industries by constantly developing electric fencing products. As a leading Chinese manufacturer of electric fences, H.P.S. Exports its products around the world.

Through technological innovation and product optimization, we continue to improve our products. We offer a wide range which include insulators, fence tools, fence testers, fence energizers, and accessories. We export our technology worldwide.

We are not only sales exporters, but are the manufacturer of the majority products we sell. We have our own factory set up with the purpose manufacturer only for H.P.S.. We have worked in cooperation with our customers to meet their needs which have also witnessed our growth. We treat every customer's enquiry with honesty and integrity to allow us to answer each customer's question with the best solution at the most competitive and reliable price, and to the most attentive service to meet customers' requirements. Our goal is to achieve a "one-stop" service for farmers.

PIGTAIL POST

PP100

- ✓ Good Flexibility
- ✓ High temperature resistant
- ✓ UV resistance
- ✓ Easy to install and disassemble

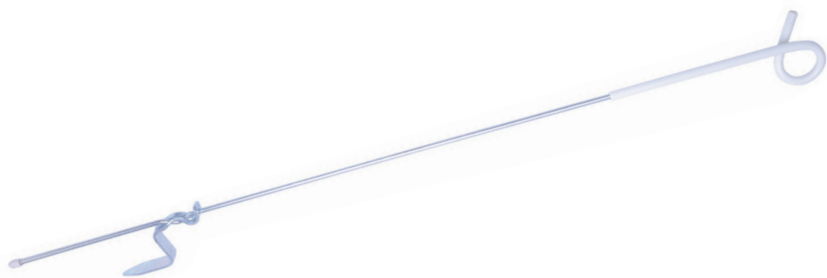

Product Parameter

Item name	Pigtail post
Item No	PP100
Type	Outriggers Pigtail Posts
Material	PE&STEEL
Length	1000MM
Color	White
Packing	60PCS/CTN
MOQ	1000PCS

Features

- ✓ Galvanised steel construction
- ✓ UV stabilized for long life
- ✓ Attach electric wire onto an existing fence
- ✓ Simply attaches to existing fencing

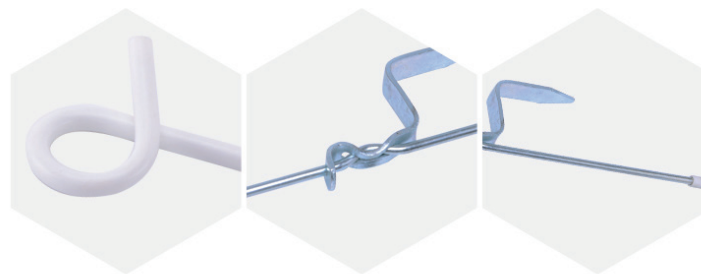

PIGTAIL POST

PT150

- ✓ Galvanised steel construction
- ✓ UV stabilized for long life
- ✓ Attach electric wire onto an existing fence
- ✓ Simply attaches to existing fencing



Product Parameter

Item name	Pigtail insulator
Item No	PT150
Type	Outriggers Pigtail Posts
Material	PE&STEEL
Length	180MM
Color	Red, White
Packing	100PCS/CTN
MOQ	500PCS

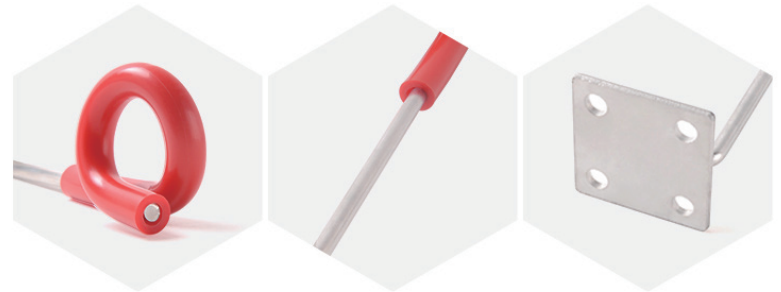
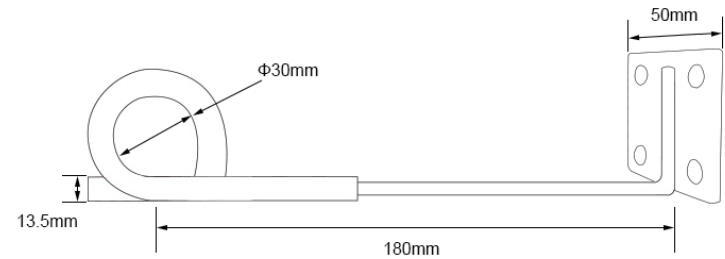

PIGTAIL POST

PT250

- ✓ Galvanised steel construction
- ✓ UV stabilized for long life
- ✓ Attach electric wire onto an existing fence
- ✓ Simply attaches to existing fencing

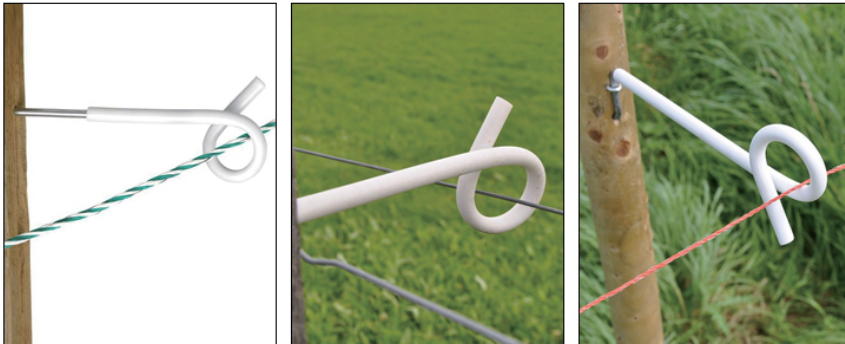

Product Parameter

Item name	Pigtail insulator
Item No	PT250
Material	PE & STEEL
Length	250mm
Color	White
Packing	60PCS / CTN
MOQ	600PCS

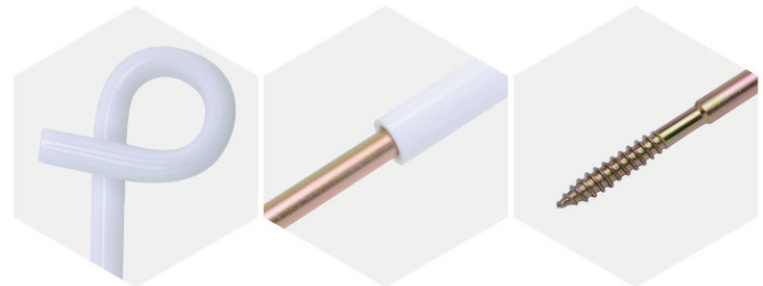
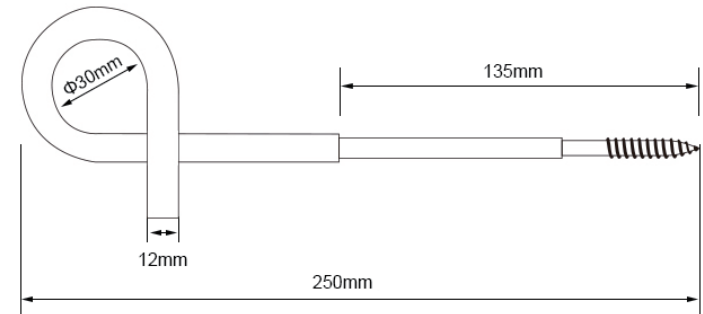

PIGTAIL POST

PTB150

- ✓ Galvanised steel construction
- ✓ UV stabilized for long life
- ✓ Attach electric wire onto an existing fence
- ✓ Simply attaches to existing fencing



Product Parameter

Item name	Pigtail insulator
Item No	PTB150
Type	Outriggers Pigtail Posts
Material	PE&STEEL
Length	150MM
Color	White
Packing	60PCS/CTN
MOQ	500PCS

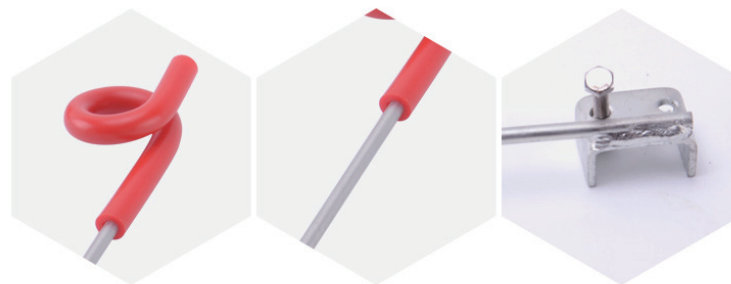
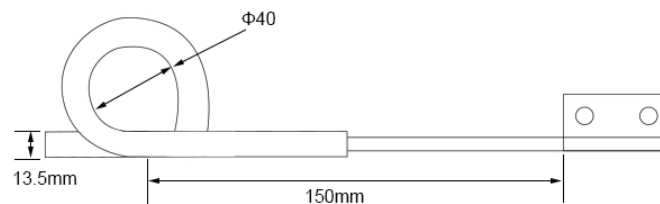

PIGTAIL POST

PTB250

- ☑ Galvanised steel construction
- ☑ UV stabilized for long life
- ☑ Attach electric wire onto an existing fence
- ☑ Simply attaches to existing fencing



Product Parameter

Item name	Pigtail insulator
Item No	PTB250
Type	Outriggers Pigtail Posts
Material	PE&STEEL
Length	250MM
Color	White
Packing	60PCS/CTN
MOQ	500PCS

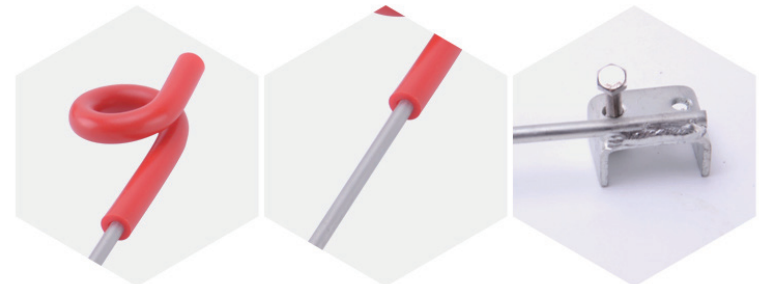
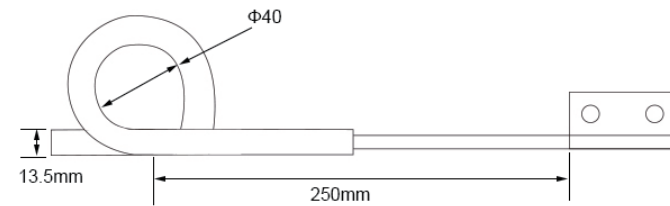

PIGTAIL POST

PTB450

- ✓ Galvanised steel construction
- ✓ UV stabilized for long life
- ✓ Attach electric wire onto an existing fence
- ✓ Simply attaches to existing fencing

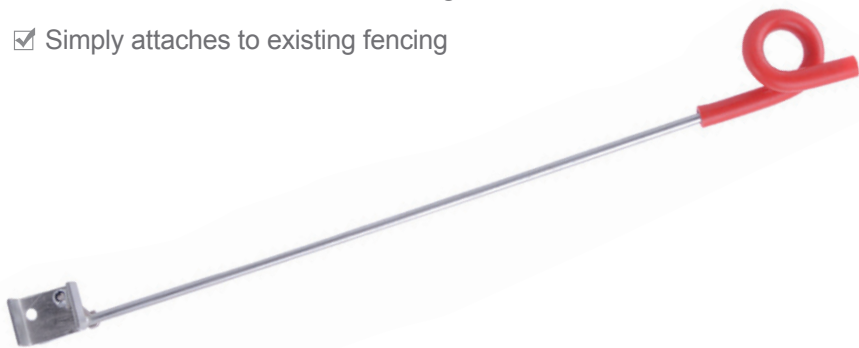

Product Parameter

Item name	Pigtail insulator
Item No	PTB450
Type	Outriggers Pigtail Posts
Material	PE&STEEL
Length	450MM
Color	White
Packing	60PCS/CTN
MOQ	500PCS

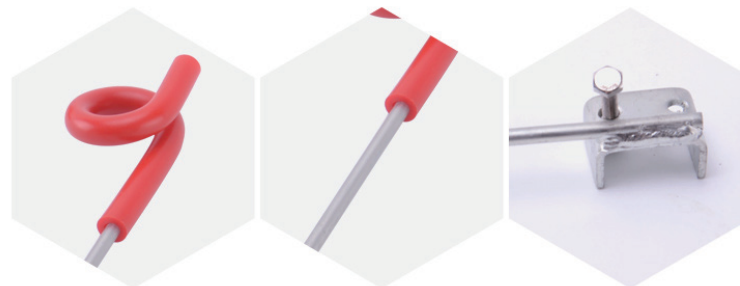
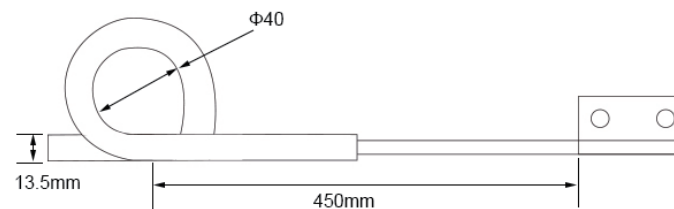

PIGTAIL POST

PTDB

- ✓ Galvanised steel construction
- ✓ UV stabilized for long life
- ✓ Attach electric wire onto an existing fence
- ✓ Simply attaches to existing fencing



Product Parameter

Item name	Pigtail insulator
Item No	PTDB
Type	Outriggers Pigtail Posts
Material	PE&STEEL
Length	500MM
Color	White
Packing	60PCS/CTN
MOQ	500PCS

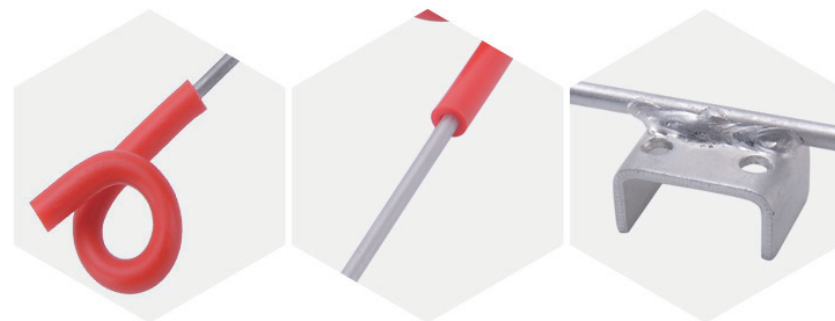
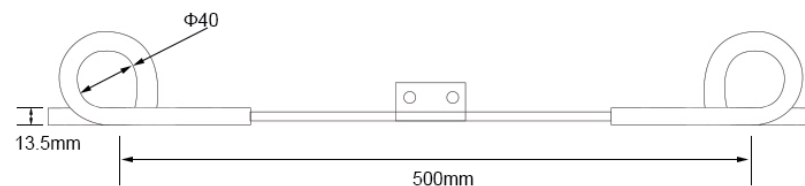

PIGTAIL POST

PTL150

- ✓ Galvanised steel construction
- ✓ UV stabilized for long life
- ✓ Attach electric wire onto an existing fence
- ✓ Simply attaches to existing fencing



Product Parameter

Item name	Pigtail insulator
Item No	PTL150
Type	Outriggers Pigtail Posts
Material	PE&STEEL
Length	150MM
Color	White
Packing	100PCS/CTN
MOQ	500PCS

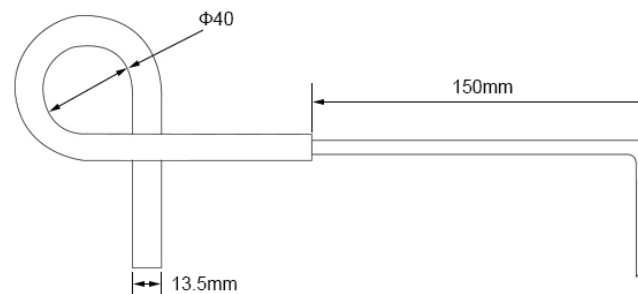

PIGTAIL POST

PTL250

- ☑ Galvanised steel construction
- ☑ UV stabilized for long life
- ☑ Attach electric wire onto an existing fence
- ☑ Simply attaches to existing fencing

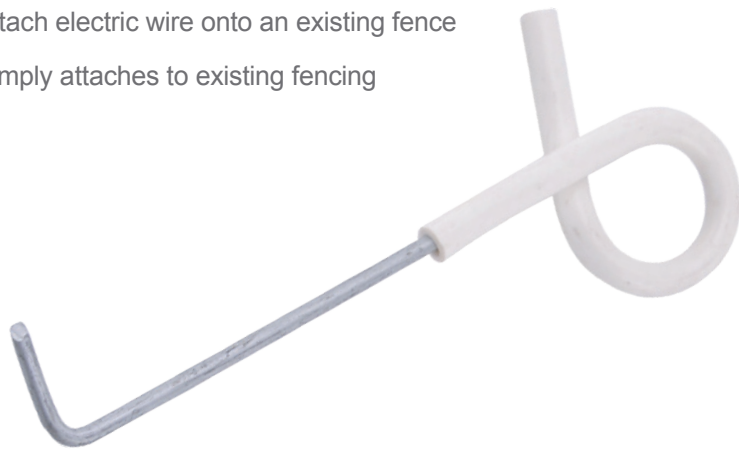

Product Parameter

Item name	Pigtail insulator
Item No	PTL250
Type	Outriggers Pigtail Posts
Material	PE&STEEL
Length	250MM
Color	White
Packing	60PCS/CTN
MOQ	500PCS

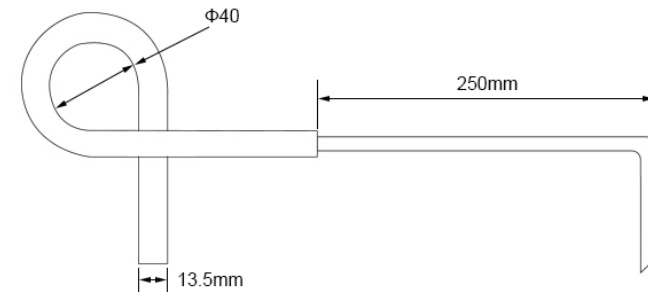

PIGTAIL POST

PTL400

- ✓ Galvanised steel construction
- ✓ UV stabilized for long life
- ✓ Attach electric wire onto an existing fence
- ✓ Simply attaches to existing fencing

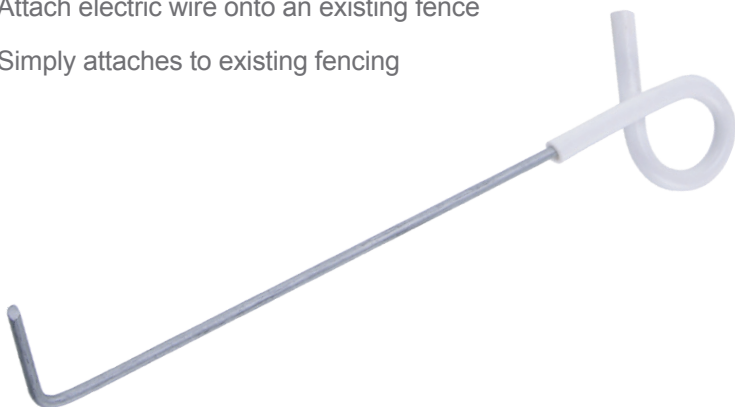

Product Parameter

Item name	Pigtail insulator
Item No	PTL400
Type	Outriggers Pigtail Posts
Material	PE&STEEL
Length	400MM
Color	White
Packing	60PCS/CTN
MOQ	500PCS

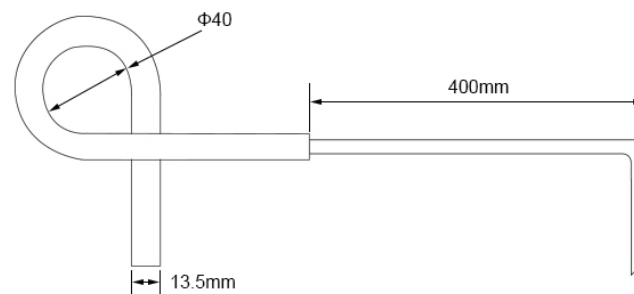

PIGTAIL POST

PTZ150

- ☑ Galvanised steel construction
- ☑ UV stabilized for long life
- ☑ Attach electric wire onto an existing fence
- ☑ Simply attaches to existing fencing

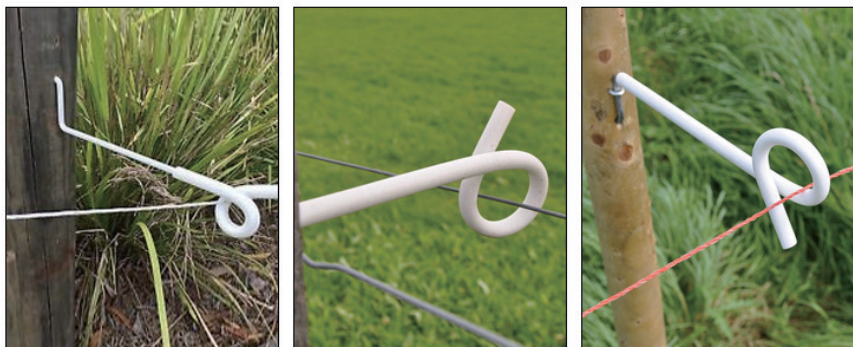

Product Parameter

Item name	Pigtail insulator
Item No	PTZ150
Type	Outriggers Pigtail Posts
Material	PE&STEEL
Length	150MM
Color	White
Packing	100PCS/CTN
MOQ	500PCS

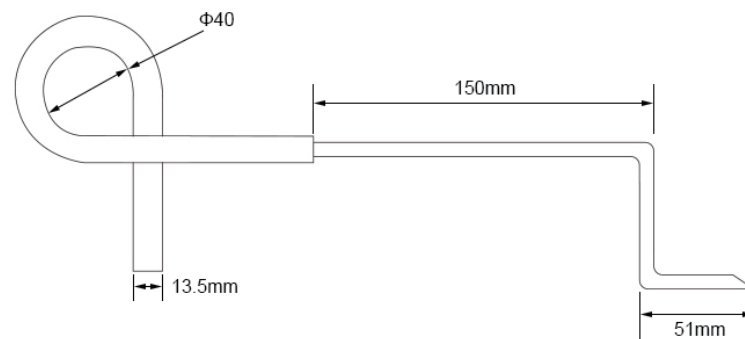

PIGTAIL POST

PTZ250

- ✓ Galvanised steel construction
- ✓ UV stabilized for long life
- ✓ Attach electric wire onto an existing fence
- ✓ Simply attaches to existing fencing

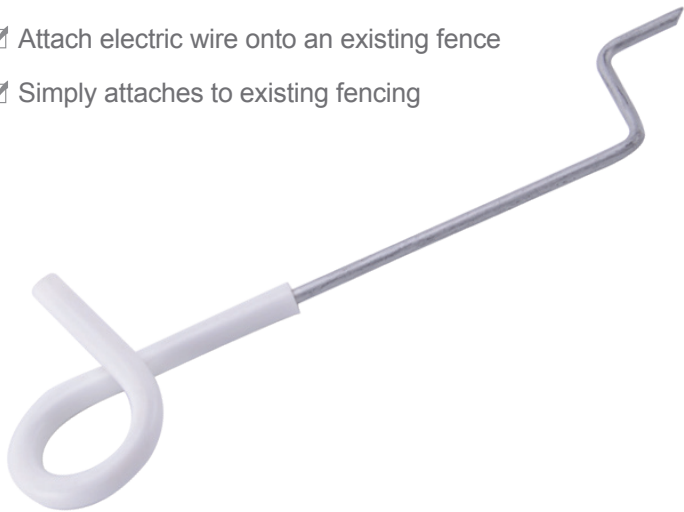

Product Parameter

Item name	Pigtail insulator
Item No	PTZ250
Type	Outriggers Pigtail Posts
Material	PE&STEEL
Length	250MM
Color	White
Packing	60PCS/CTN
MOQ	500PCS

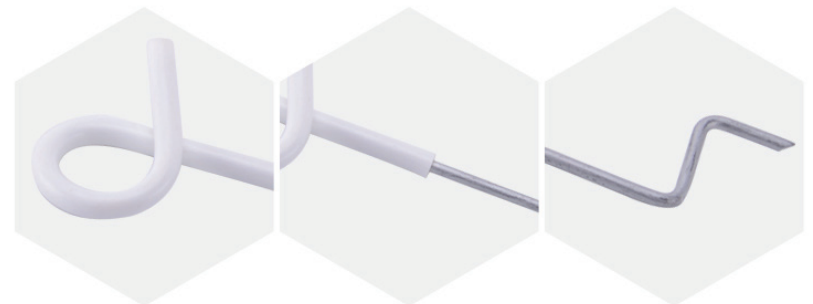
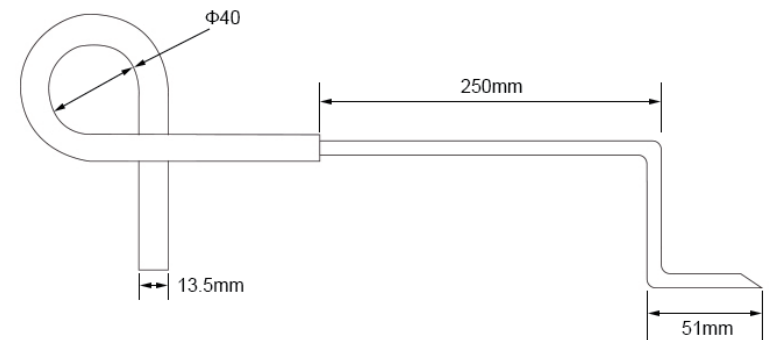

PIGTAIL POST

PTZ400

- ☑ Galvanised steel construction
- ☑ UV stabilized for long life
- ☑ Attach electric wire onto an existing fence
- ☑ Simply attaches to existing fencing

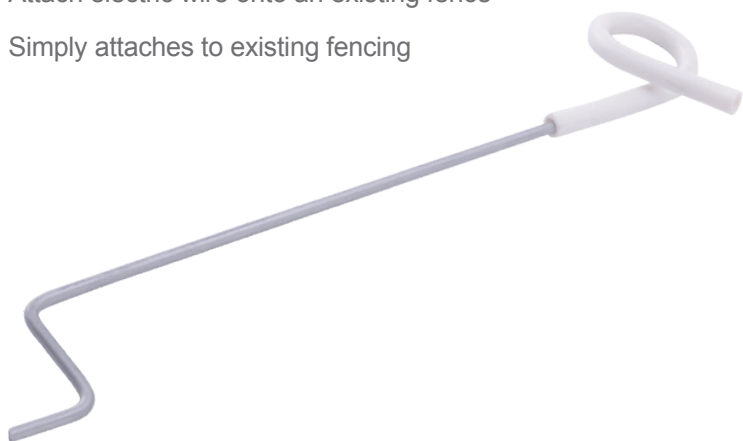

Product Parameter

Item name	Pigtail insulator
Item No	PTZ400
Type	Outriggers Pigtail Posts
Material	PE&STEEL
Length	400MM
Color	White
Packing	60PCS/CTN
MOQ	500PCS

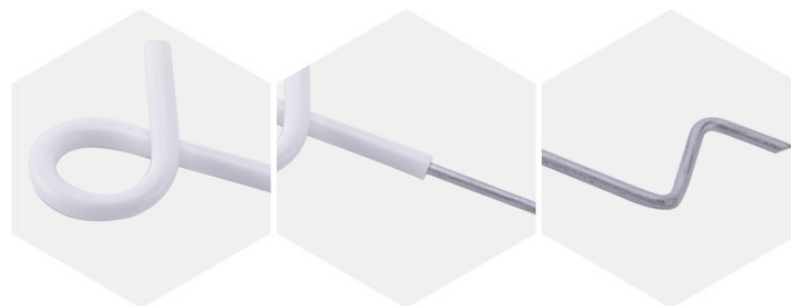
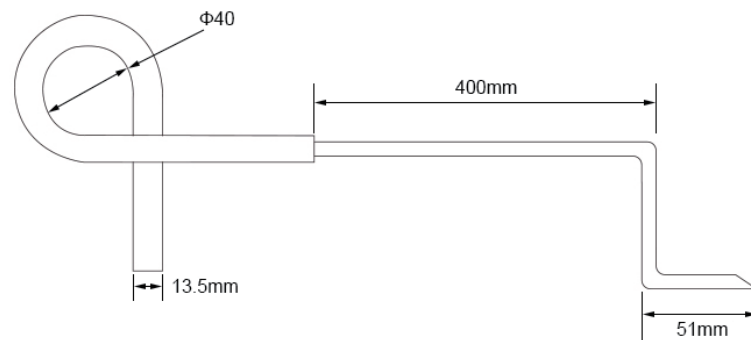



HANGZHOU OPUS FENCE SUPPLIES CO.,LTD

Tel: 86-571-89774060

Fax: 86-571-89774057

Email: hps01@hpsunionpower.com

Add: D406, No.11, Xiyuan 8th Road, West Lake Science&
Technology Park Hangzhou, China, 310030

www.hpsfence.com

<http://hpsfence.en.alibaba.com>